

nutribullet
JUICER PRO™



User guide.

Important safeguards.

Warning! To avoid the risk of serious injury, carefully read all instructions before operating your NutriBullet Juicer Pro™. When using any electrical appliance, basic safety precautions should always be observed, including the following important information.

! Save these instructions! ● FOR HOUSEHOLD USE ONLY

GENERAL SAFETY INFORMATION

- This juicer system has sharp blades and moving parts, and is **NOT** intended for use by children or persons with reduced physical, sensory, or mental capabilities, or who lack experience and knowledge of its safe operation. Such persons require close supervision and thorough instruction on its proper use and safe operation. Close supervision is necessary when any appliance is used by or near children. Children should be supervised to ensure that they do not play with the appliance.
- To protect against fire, electrical shock and injury to persons, do not immerse the juicer, Motor Base, cord or plug in water or any other liquid.
- Turn the juicer **OFF**, then unplug from the outlet when not in use, before assembling or

disassembling parts and before cleaning. To unplug, grasp the plug and pull from the outlet. Never pull from the power cord.

AVOID CONTACT WITH MOVING PARTS.

- Regularly inspect the power supply cord, plug, and actual juicer for any damage
- Do not operate this or any appliance with a damaged cord or plug or after the appliance malfunctions, or is dropped or damaged in any manner. Contact Customer Service for assistance at **1 (800) 523-5993**.
- The use of attachments not recommended or sold by NutriBullet® may cause fire, electric shock, or injury.
- This juicer is for household use only. Do not use this juicer for anything other than its intended use. Do not use in moving vehicles or boats. Do not use outdoors. Misuse may cause injury.

- Do not let the power cord hang over the edge of a table or counter top.
- Do not let the power cord touch hot surfaces, such as a stove or let it become tangled or knotted.
- Always make sure the pulp basin cover is securely in place (with locking handle in its upright and locked position) before the motor is turned on. Do not unlock the locking handle while the juicer is in operation.

Always ensure the juicer is turned OFF after each use. Before disassembling, make sure the sieve has stopped rotating and the motor has completely stopped.

- Do not push food into the feed chute with your fingers or utensils. Always use the food pusher provided. Do not place your hand or fingers into the feed chute when it is attached to the juicer. If food becomes lodged in the feed chute, use the food pusher provided or another piece of fruit or vegetable to push it down. Turn the motor off and ensure that all moving parts have stopped before disassembling the juicer to remove the remaining pulp.

- Do not use the juicer if the rotating sieve is damaged.
- Do not use the juicer without the pulp basin and basin cover attached to the motor base. Please see assembly instructions for proper placement.
- Do not modify the plug in any way. This juicer has a polarized plug. To reduce the risk of electric shock, this plug will fit in a polarized outlet only one way. If the plug does not fit fully in the outlet, reverse the plug. If it still does not fit, contact a qualified electrician.

ADDITIONAL SAFEGUARDS

Remove and safely discard any packaging material or promotional labels before using the juicer for the first time.

- To eliminate a choking hazard for young children, remove and safely discard the protective cover fitted to the power plug of this juicer.
- Do not touch the small cutting blades/teeth on the bottom/base of the sieve. **BLADES ARE SHARP! HANDLE WITH EXTREME CARE!**
- Keep fingers away from the sharp blade in the feed chute.

Always make sure the Juicer is properly and completely assembled before connecting to power outlet and operating.

Ensure that the surface where the appliance operates is stable, level, clean and dry.

- Vibration can occur during normal operation.
- If extreme vibration occurs, discontinue use and call Customer Service.
- If the juicer leaks or there is a spill under or around the juicer, or onto the juicer itself, clean and dry before continuing use.
- When using this juicer, make sure there is adequate air space around and under it for proper air circulation.

This juicer is only designed to juice fruits and vegetables. Please refer to the juicing guide to determine the correct speed for the fruits and vegetables selected for juicing. Do not use any frozen fruits or vegetables.

- Hard fruits and vegetables will put excess strain onto the motor if a low speed is selected.

- **Remove rind from all citrus fruits before juicing.**
- Do not juice stone fruit unless pits or seed stone has been removed.

WARNING!

Do not leave the appliance unattended while in use.

Keep hands, fingers, hair, clothing as well as spatulas and other utensils away from the appliance during operation.

Keep the juicer clean. Refer to care and cleaning section for further information.

Any maintenance other than cleaning should be performed by an authorized electrician. Do not attempt to repair or service this juicer, contact Customer Service for assistance at **1 (800) 523-5993**.

- **If any of the instructions or warnings are not understood please contact Customer Service for assistance at 1 (800) 523-5993.**



Contents.

- 03 Important safeguards**
- 08 What's included**
- 09 Assembly guide**
- 10 Assembly & use**
 - 12 Usage instructions
 - 17 Control panel
 - 18 Juicing tips
- 22 Disassembly**
- 24 Care and maintenance**
- 25 Juice and unit storage**
- 26 Troubleshooting guide**
- 26 Replacement parts**
- 27 NutriBullet Juicer Pro™
one-year limited warranty**
- 30 Warranty registration**

Thank you for purchasing the NutriBullet Juicer Pro™.

What's included.



**1000 WATT MOTOR
BASE WITH
LOCKING HANDLE**

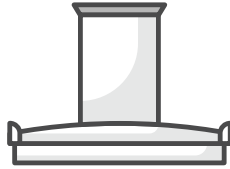

**PULP BASIN COVER
WITH 3" FEED CHUTE**

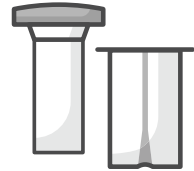

**DUAL-SIZE
FOOD PUSHER**

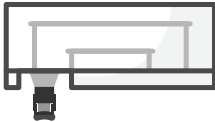

**2L PULP BASIN
WITH NO-DRIP SPOUT**



STAINLESS STEEL SIEVE



27 OZ JUICE PITCHER



**JUICE PITCHER LID
WITH FROTH SEPARATOR**



CLEANING BRUSH



**TWO 12 OZ GLASS
STORAGE BOTTLES**

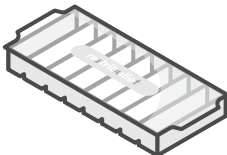

2 OZ FREEZER TRAY

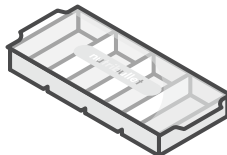

4 OZ FREEZER TRAY

Assembly guide.

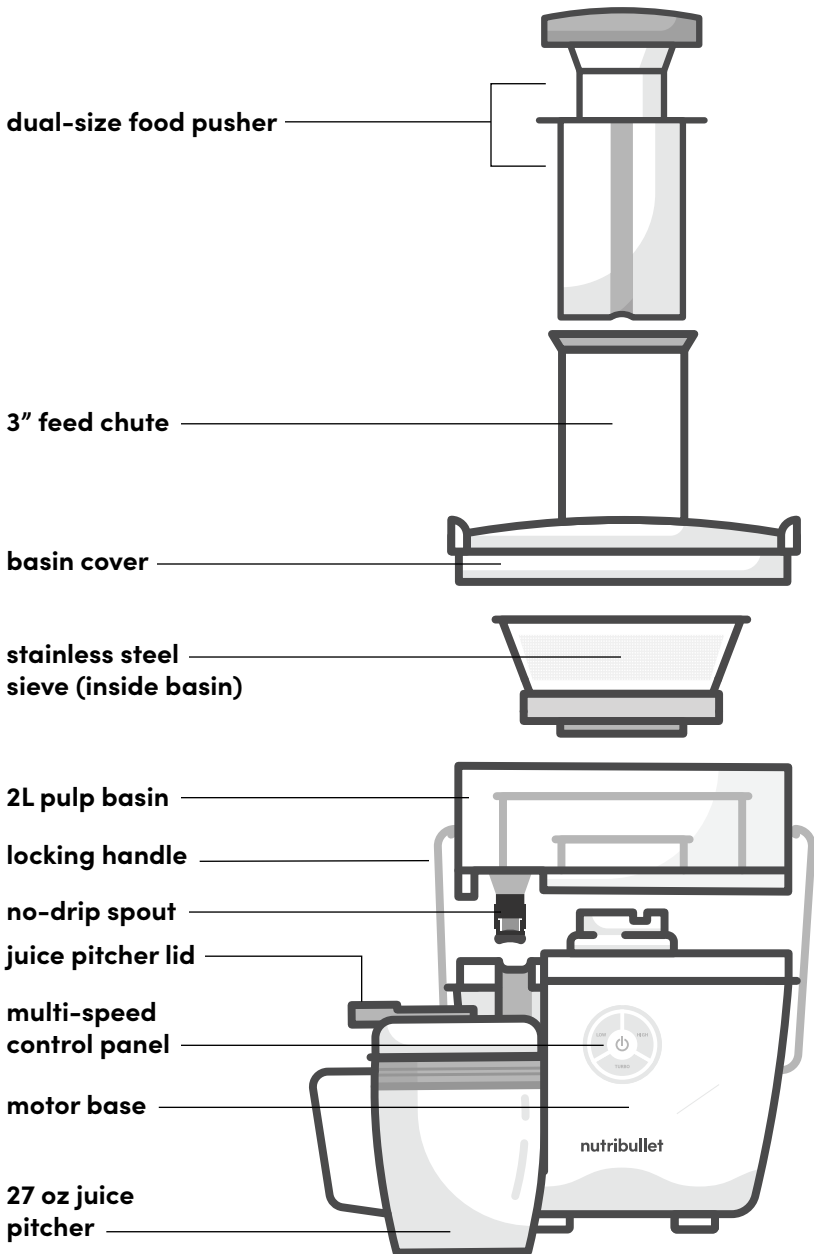

Assembly & use.



- 1 Place the **Motor Base** on a dry, level counter top. Ensure the dial is set to the **"OFF"** position and the unit is unplugged.

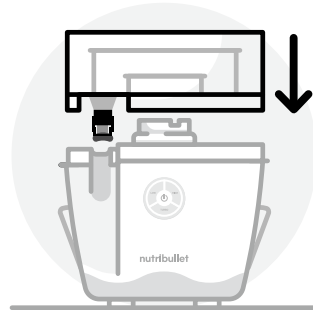

- 2 Place the **Pulp Basin** on top of the Motor Base. Align the **Pulp Basin** with the Motor Base so that the spout is aligned with the dimpled side of the Motor Base.

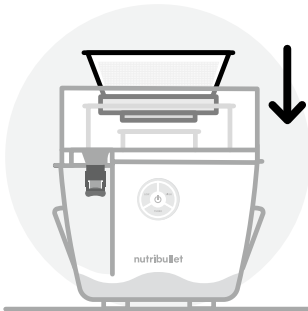

- 3 Align the **Sieve** with the motor drive coupling and push down until it clicks into place. Handle the **Sieve** by gripping the top edges being careful not to touch the sharp teeth on the base of the **Sieve**. Ensure the **Sieve** is properly seated in place and securely inside of the Pulp Basin.

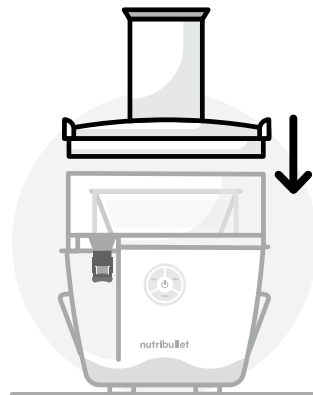

- 4 Place the **Basin Cover** over the Sieve and Pulp Basin. The side "ears" on the **Basin Cover** should align with the "ears" on the sides of the Pulp Basin.

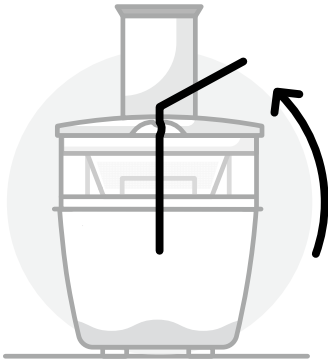

- 5** Raise the **Locking Handle** and move it into the “ears” on each side of the Basin Cover. The **Locking Handle** should be in a vertical position and locked into place.

NOTE: if the **Locking Handle** is not securely in place, the juicer will not power on.

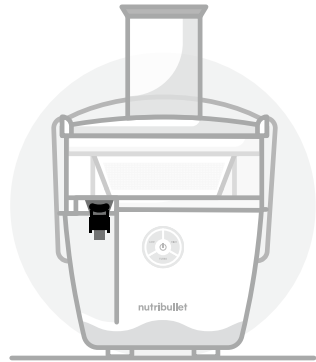

- 6** Swing the **No-Drip Spout** cover up vertically so that it is no longer covering the juice spout.



- 7** Place the **Juice Pitcher Lid** on top of the Juice Pitcher, and open the locking lid latch.



- 8** Slightly angle the **Juice Pitcher** and place it under the juice spout. Align the spout with the hole in the **Juice Pitcher Lid** and level out the **Juice Pitcher**. It will fit snugly into the spout to hold it in place.

Usage instructions.



- 1** Gather all of your desired ingredients. Wash and prepare them for juicing.

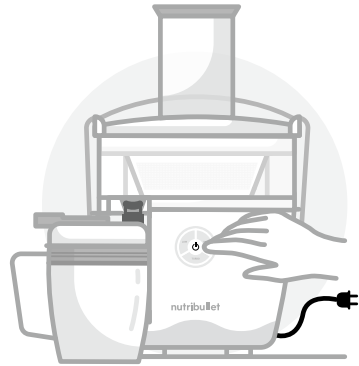

- 2** After the juicer is fully assembled, plug the power cord into an outlet.

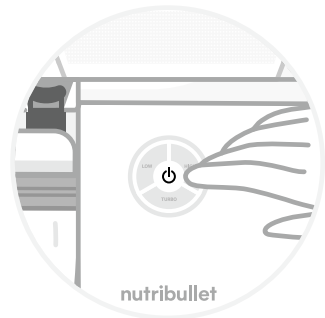

NOTE: If no speed is selected after 10 minutes, the unit will power off.

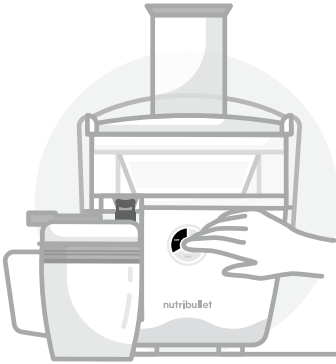

- 3** Select a speed to begin juicing. The speed selected will illuminate on the control panel. You may start at any speed and can toggle between speeds as desired depending on the type of produce (refer to the chart on page 18 for recommended speeds for each type of produce).

NOTE: always start the juicer before putting food in the feed chute.



- 4** To operate the **Dual-Size Food Pusher**, grip the outer edge of the top of the pusher with one hand and the bottom of the pusher with the other hand. Twist the top of the pusher clockwise to unlock the inner pusher. (The inner pusher is thinner than the full pusher.)

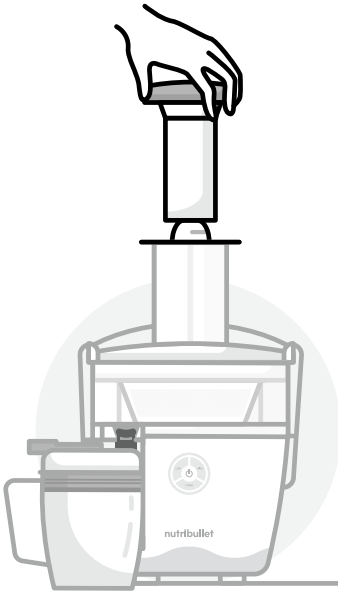

- 5** If you are using smaller ingredients (smaller fruits, leafy greens, stalk vegetables like celery or carrots), place the outer part of the pusher into the chute, making the chute more narrow. While the motor is running, begin gently guiding ingredients into the internal chute using the inner pusher.

TIP: When using the narrow chute for juicing leafy greens, take a small handful of greens and squeeze them into a tighter bunch. Place the bunch into the chute and slowly push down into the Sieve. Using the narrow chute will help to prevent any pieces from flying up out of the chute.

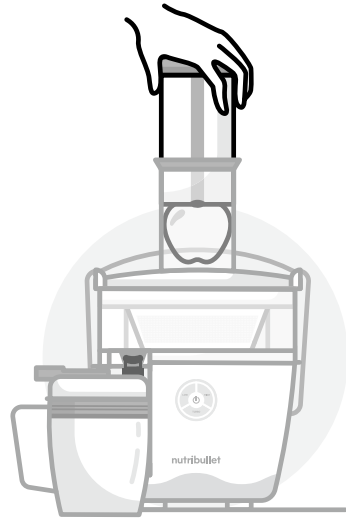

- 6** If you are using larger ingredients, keep the feed chute empty (creating a wider chute) and lock the inner pusher back inside the outer pusher. While the motor is running, begin gently guiding your ingredients into the feed chute using the full **Dual-Size Food Pusher**.

NOTE: You may alternate between the two chute sizes (narrow and wide) as you are juicing.



WARNING: Do not use excess force when pushing food down with the **Food Pusher**, as it will not allow for maximum juice yield.



WARNING: Never use hands/fingers or other tools to push ingredients down the feed chute into the Sieve. Only the **Food Pusher** should be used to push down ingredients.

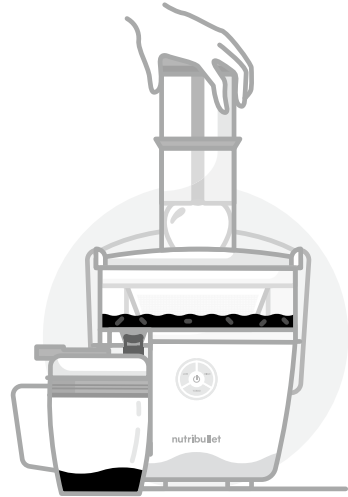

- 7** Juice will begin to flow out of the spout and into the **Juice Pitcher**, while the pulp will be separated and stored in the **Pulp Basin**.



- 8** When the **Pulp Basin** is completely full, it must be emptied before continuing juicing. See disassembly instructions.



- 9** To stop juicing, press the speed at which you are currently juicing. To completely power off the juicer, press the center power button and wait for the **Sieve** to stop spinning. Unplug the unit after each use.



- 10** Remove the **Juice Pitcher** from under the spout. You may close the **Juice Pitcher Lid** and store juice in the **Juice Pitcher** if desired.

NOTE: To do this, you'll first need to tip the **Juice Pitcher** forward at a slight angle, so that the lid's large hole has some separation from the spout, then you can slide out the pitcher. This is the reverse of what you did during assembly.

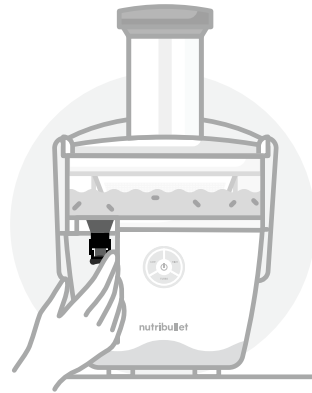

- 11** Immediately move the **No-Drip Spout** cover downward over the spout to avoid any residual drips onto the unit or onto the surface below the juicer.

TIP: We recommend using your left hand to pull the **Juice Pitcher** away, while using your right hand to swing the **No-Drip Spout** cover down and over the spout opening.

Control panel.

MULTI-SPEED CONTROL PANEL & JUICING SETTINGS.

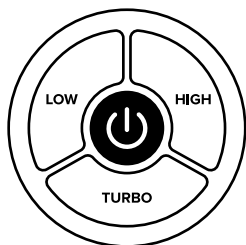

OFF:

Power is **OFF**. If the unit is **ON**, the center power button will be illuminated. Pressing the center button will turn the unit **OFF**.

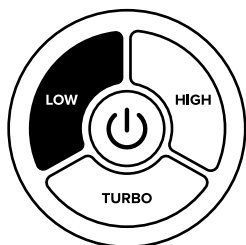

LOW:

Best for juicing softer fruits and vegetables.

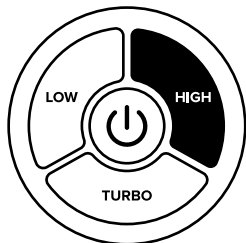

HIGH:

Best for harder produce like pineapples.

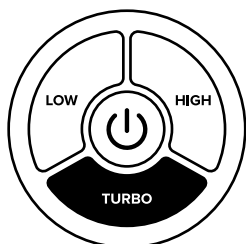

TURBO:

Best for juicing the toughest vegetables like beets or carrots.

Juicing tips.

JUICING SPEED SELECTION GUIDE

INGREDIENTS	SPEEDS	SEASONS
Apple	Turbo	All Year
Beets	Turbo	Summer / Fall / Winter
Blueberry	Turbo	Summer
Broccoli	Turbo	Fall / Spring
Brussels Sprouts	Turbo	Fall / Winter
Cabbage	Low	Fall / Winter / Spring
Carrots	Turbo	All Year
Cauliflower	Turbo	Fall
Celery	Turbo	All Year
Cucumber	High	Summer
Fennel	Turbo	All Year
Ginger	Turbo	Fall
Grapes	Low	Fall
Grapefruit	Low	Winter
Kale	High	Fall / Winter / Spring
Kiwi	Low	Fall / Winter / Spring
Lemon	Low	All Year
Lime	Low	All Year
Melons (all)	Low	Summer
Orange	Turbo	Winter
Peaches	High	Summer
Pears	High	Fall / Winter
Pineapple	High	Fall / Winter / Spring
Plums	High	Summer
Raspberries	Low	Summer / Fall
Spinach	Low	Fall / Spring
Sweet Potato (raw)	Turbo	Fall / Winter
Tomatoes	Low	Summer

VITAMINS / NUTRIENTS

source of quercetin

excellent source of folate

good source of vitamin C

high in vitamin C, high in folate, good source of potassium

high in vitamin C, good source of folate

high in vitamin C

excellent source of vitamin A, good source of vitamin C

high in vitamin C, good source of folate

good source of vitamin C, good source of vitamin A

good source of vitamin C

good source of vitamin C and potassium

contains vitamin C, magnesium, and potassium

good source of vitamin K

high in vitamin A, high in vitamin C

excellent source of vitamin A and vitamin C, good source of calcium and potassium

high in vitamin C, good source of potassium and vitamin E

high in vitamin C

high in vitamin C

high in vitamin A, high in vitamin C

high in vitamin C

good source of vitamin C

good source of vitamin C

high in vitamin C

good source of vitamin C

high in vitamin C

high in vitamin A, vitamin C, iron, and folate, good source of magnesium

good source of potassium, high in vitamin A and vitamin C

high in vitamin A, high in vitamin C, good source of potassium

PROPER PRODUCE PREP

Prepare fruit and veggies before inserting them into the juicer:

- Properly clean produce (rinse with produce wash, or lukewarm water and apple cider vinegar).
- Peel or remove skin as needed, and chop food items down to the right size – just small enough to fit easily into the feed chute, without having to force the pieces down with the **Food Pusher**.
- Remove rind from all citrus fruits before juicing.
- Remove large pits and seeds from stone fruits before juicing.

FEED CHUTE

Selecting which **Food Pusher** to use (narrow or wide) affects feed chute thickness. If you pull out the thinner inner food pusher from within the full pusher, you'll place the outer part into the chute, making the chute narrow. If you use the full (wide) pusher, the feed chute will be wider.

- Never place your hand or fingers into the feed chute when it is attached to the juicer.
- Always start the juicer before adding food to the feed chute. The unit must be running when items enter it.
- Do not overload the feed chute. Items must be added gradually, at a pace the juicer can keep up with.
- Use only the provided **Food Pusher** to push food into the feed chute. Never use fingers, utensils, or any other apparatus.
- Never use excessive force to push items into the feed chute.
- When juicing, ensure all produce has moved through the feed chute and into the **Sieve** before adding more.
- If any food gets stuck in the feed chute, use the **Food Pusher** to move it down the chute and into the **Sieve**.

CONSUMING JUICE AND PULP

Instead of composting or throwing away the pulp left over after juicing, you can choose to consume it. See our **Recipe Guide** for some fun tips on what to do with the leftover pulp. By using these creative ideas, you can enjoy pulp in a variety of delicious (and healthy) ways.

- Whether you prefer sweet or savory, you can use pulp to create some tasty treats!
- For best taste, consume fresh juice and pulp within 48 hours of juicing.

NO-GO FOODS

Foods that should NEVER be used in this juicer:

- Thicker foods that do not contain juice to extract (for example, bananas or avocados).
- Frozen fruits or vegetables.
- Stone fruits that have large pits or seeds that have not been removed. Stone fruits may be used only if the seed or pit has been removed.

OVERHEATING, SPEED SELECTION, & AUTO SHUT-OFF

- If the motor overheats, the juicer will turn off.
- If the juicer stops working, unplug it and allow it to cool down for at least fifteen minutes before attempting to use again.
- Refer to the Troubleshooting Guide for instructions on what to do if the unit turns off or is not working.

Disassembly.



- 1** Ensure the unit is powered **"OFF"** and unplugged.

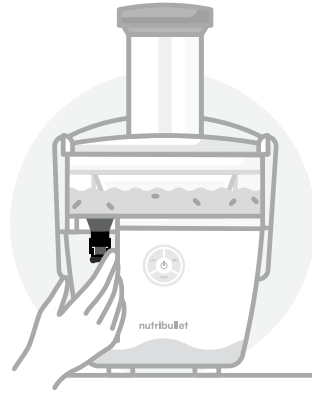

- 2** Remove the pitcher from under the spout. To prevent drips use the **No-Drip Spout** cover to close the juice spout.

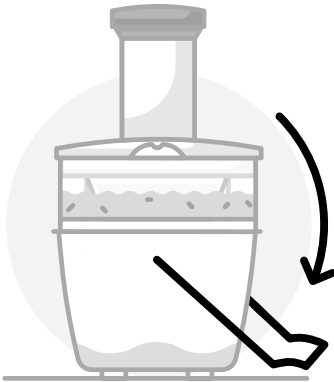

- 3** Unlock the **Locking Handle** from the **Basin Cover** by pulling the handle backward out of the "ears" on either side of the **Basin Cover**. Move the handle down.

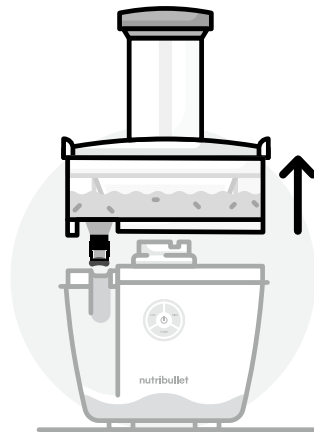

- 4** Remove the **Pulp Basin** from the Motor Base by pulling upwards with the **Basin Cover** and **Sieve** still in place, and take it directly to your sink.

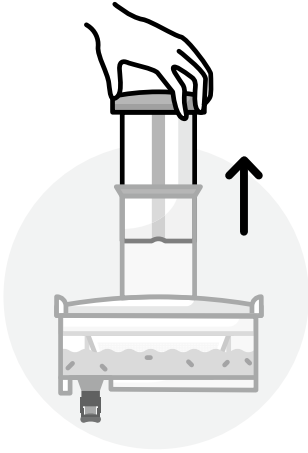

- 5** Remove the **Food Pusher** by lifting it out of the feed chute.

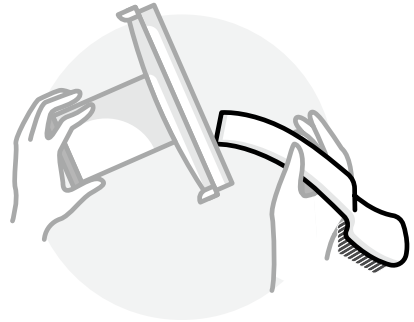

- 6** Lift the Basin Cover vertically off of the Pulp Basin and remove any pulp from the inside of the cover. You may use the flat end of the **Cleaning Brush** to scrape pulp off of the cover.

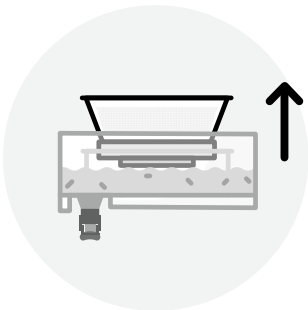

- 7** Gently lift the **Sieve** vertically out of the center of the Pulp Basin. Clean the **Sieve** right away (see care instructions).

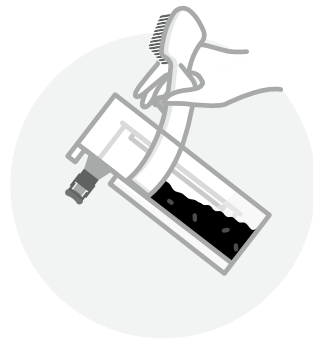

- 8** Empty the **Pulp Basin**. Use the flat end of the **Cleaning Brush** to easily scrape out the pulp and set it aside for use in other recipes or composting. Or empty the pulp into your waste bin or compost.

Care & maintenance.

Cleaning the NutriBullet Juicer Pro™ is quick and easy. All components except for the Food Pusher and Motor Base are dishwasher safe. Read on for some cleaning tips and best practices.

- 1** Always ensure the **Motor Base** is unplugged before you begin assembly, disassembly, cleaning or storage of the unit.
- 2** Once the **Pulp Basin** is emptied, rinse all parts under running water.
- 3** Use the **Cleaning Brush** to scrub the **Sieve** under running water. Be sure to properly clean the **Sieve** every time you juice, as minerals from fruits and vegetables can cause build-up in the **Sieve** which may prohibit maximum juice extraction.



WARNING: Always use precaution when cleaning the **Sieve**, as it contains sharp blade teeth on the flat disc part.

TIP: Always clean the **Sieve** as soon as possible after juicing using the **Cleaning Brush**. If allowed to sit, pulp will dry on the **Sieve** and it will become more difficult to scrub blocked holes. If this happens, be sure to allow the **Sieve** to soak in hot water for 30 minutes.

- 4** All Juicer Pro components except the **Food Pusher** and **Motor Base** are dishwasher safe. You may also hand wash with warm soapy water.

TIP: Do not use the Sterilize cycle on your dishwasher to clean your juicer as it may cause parts to deform.

- 5** Wipe down **Motor Base** with a clean, damp cloth.



WARNING: Never submerge **Motor Base** into water or other liquid.

Cleaning instructions for your NutriBullet Juicer Pro™ storage accessories:

- **Glass Storage Bottles** and lids are dishwasher safe.
- **Freezer Trays** and lids are dishwasher safe.

Juice & unit storage.

Included with your Juicer Pro are some great storage accessories: a Juice Pitcher, two Juice Storage Bottles, and two Freezer Trays.

The storage accessories give you three options for storing juice:

1 IN THE PITCHER:

The **Juice Pitcher** stores up to 27 ounces. Make sure to store the pitcher upright in your refrigerator, with lid tightly sealed, latch closed, and nothing atop the lid.

2 IN THE BOTTLES:

Use each **Storage Bottle** to save up to 12 ounces of juice, so you can enjoy it later — either at home or on the go. Fill up the bottles leaving about a quarter of an inch of room at the top, leaving just enough air in the bottle.

3 IN THE TRAYS:

Each **Freezer Tray** holds a total of 16 ounces: one tray has eight 2-ounce wells, and the other tray has four 4-ounce wells. These are a great way to preserve juice longer-term, then defrost it anytime for a full drinkable portion. Or, use the trays to make frozen juice shots. (See our **Recipe Guide** for some inspiring recipes for frozen juice shots to add to your favorite beverages, or to drink on their own.)

For best taste, consume fresh juice and pulp within 48 hours of juicing.

Do not place anything on top of the Pitcher Lid when storing in the refrigerator.

Store remaining pieces of the unit in a safe place where they will not be damaged and won't cause harm as some pieces are sharp!

Troubleshooting guide.

- 1 PROBLEM:** The power button flashes three times and then remains illuminated when I select a speed.

SOLUTION: This means that the unit is not properly assembled. Ensure the **Pulp Basin** is properly seated on top of the **Motor Base**, and the **Locking Handle** is locked into place.

- 2 PROBLEM:** The juicer stopped in the middle of juicing, and the power button flashed.

SOLUTION: Ensure the **Locking Handle** is securely locked into place.

- 3 PROBLEM:** The juicer stopped in the middle of juicing, and the power button remains illuminated.

SOLUTION: You have exceeded 10 minutes of continuous running time. Unplug the juicer and keep the unit off for 15 minutes before continuing use.

- 4 PROBLEM:** The juicer has stopped running, and all lights flashed three times.

SOLUTION: The juicer has overheated. Unplug the unit and allow it to cool down for 15 minutes before continuing use.

Replacement parts.

To order additional parts and accessories, please visit our website at nutribullet.com/shop/accessories or contact Customer Service at 1 (800) 523-5993.

NutriBullet Juicer Pro™ one-year limited warranty.

LIMITED WARRANTY FOR NUTRIBULLET®

NutriBullet's limited warranty obligations are confined to the terms set forth below:

NutriBullet, LLC and Capital Brands Distribution, LLC (together, "NutriBullet") warrants this NutriBullet® against defects in materials and workmanship for a period of one year from the date of original retail purchase. This limited warranty is valid only in the country in which the product is purchased and comes with the product at no extra charge, however shipping and processing fees will be incurred by you for returns, replacements and/or refunds. If a defect exists and subject to this limited warranty, at its option NutriBullet will (1) repair the product at no charge, using new or refurbished replacement parts, (2) exchange the product with a product that is new or that has been manufactured from new or serviceable used parts and is

at least functionally equivalent to the original product, or (3) refund the purchase price of the product. A replacement product assumes the remaining warranty of the original product. A repaired product has a one-year warranty from the date of repair. When a product or part is exchanged, any replacement item becomes your property and the replaced item becomes NutriBullet's property. When a refund is given, your product becomes NutriBullet's property.

OBTAINING WARRANTY SERVICE

For limited warranty service, simply call our Customer Service Department at **1 (800) 523-5993** or contact us via email from our website at **nutribullet.com**, simply click the contact us link, fill out and submit the customer contact form and we will be glad to help you. When you contact our Customer Service Department you will be asked for your name, address, telephone number and to provide proof of the original purchase (receipt)

containing a description of the product(s), purchase date, and the appropriate NutriBullet® serial number(s). Before you send your product for limited warranty service please make sure to keep a copy of all relevant documents for your files (receipt, etc.). It is always recommended to purchase product insurance and tracking services when sending your product for service. Remember, shipping and processing fees will be incurred by you and are not covered by the one-year limited warranty.

EXCLUSIONS & LIMITATIONS

This NutriBullet® One-Year Limited Warranty applies only to NutriBullet® products distributed by or for NutriBullet that can be identified by the “NutriBullet” trademark, trade name, logo and bar code. This NutriBullet® Juicer Pro™ One-Year Limited Warranty does not apply to any unauthentic product or accessory that were not distributed/sold by NutriBullet.

Normal wear and tear is not covered by this limited warranty.

This limited warranty applies to household use only, and is void when the product is used in a commercial or institutional setting.

This limited warranty extends only to the original consumer purchaser and is not transferable. In addition, proof of purchase must be demonstrated.

Repair or replacement of the product (or, if repair or replacement is not feasible, a refund of the purchase price) is the exclusive remedy of the consumer under this limited warranty. NutriBullet shall not be liable for any incidental or consequential damages for breach of this limited warranty or any implied warranty on this product.

This limited warranty gives you specific legal rights, and you may also have other rights which vary from state to state. NutriBullet is not liable for any damage to products not covered by this warranty (e.g., cups, book, User Guide). This limited warranty does not apply: (a) to damage caused by accident, abuse, misuse, or misapplication; (b) to damage caused by improper maintenance (including unauthorized parts service); (c) to a product or a part that has been modified in any way; (d) if any NutriBullet® serial number or trademark has been removed or defaced; (e) if the product has been used with an adapter/converter; and/or (f) if the product is used for commercial or industrial purposes.

THIS LIMITED WARRANTY AND THE REMEDIES SET FORTH ABOVE ARE EXCLUSIVE AND IN LIEU OF ALL OTHER WARRANTIES, REMEDIES AND CONDITIONS, WHETHER ORAL OR WRITTEN, EXPRESS OR IMPLIED. NUTRIBULLET SPECIFICALLY DISCLAIMS ANY AND ALL IMPLIED WARRANTIES, INCLUDING, WITHOUT LIMITATION, WARRANTIES OF MERCHANTABILITY AND FITNESS FOR A PARTICULAR PURPOSE. IF NUTRIBULLET CANNOT LAWFULLY DISCLAIM IMPLIED WARRANTIES UNDER THIS LIMITED WARRANTY, ALL SUCH WARRANTIES, INCLUDING WARRANTIES OF MERCHANTABILITY AND FITNESS FOR A PARTICULAR PURPOSE ARE LIMITED IN DURATION TO THE DURATION OF THIS LIMITED WARRANTY.

No NutriBullet® reseller, agent, or employee is authorized to make any modification to this warranty.

NUTRIBULLET IS NOT RESPONSIBLE FOR DIRECT, SPECIAL, INCIDENTAL OR CONSEQUENTIAL DAMAGES RESULTING FROM ANY BREACH OF WARRANTY OR CONDITION, OR UNDER ANY OTHER LEGAL THEORY, INCLUDING BUT NOT LIMITED TO LOST PROFITS, DOWNTIME, GOODWILL, DAMAGE TO OR REPLACEMENT OF EQUIPMENT AND PROPERTY. NUTRIBULLET SPECIFICALLY

DOES NOT REPRESENT THAT IT WILL BE ABLE TO REPAIR ANY PRODUCT UNDER THIS LIMITED WARRANTY.

Some states and provinces do not allow the exclusion or limitation of incidental or consequential damages or exclusions or limitations on the duration of implied warranties or conditions, so the above limitations or exclusions may not apply to you. This warranty gives you specific legal rights, and you may also have other rights that vary by state or province.

Warranty registration.

Please visit nutribullet.com/warranty-registration or call **1 (800) 523-5993** to register your new NutriBullet Juicer Pro™. You will be asked to enter the **Serial Number*** of your product, along with the purchase date and place of purchase.

The registration will enable us to contact you in the unlikely event of product safety notification. By registering your product you acknowledge to have read and understood the instructions for use, and the warnings set forth in the accompanying instructions.

To find the serial number, check under the Motor Base.

If you cannot find the serial number, call Customer Service for assistance.



How to find serial number under the Motor Base.

1 (800) 523-5993 | nutribullet.com

NUTRIBULLE[®] is the registered trademark of CAPBRAN HOLDINGS, LLC
Copyright © 2020 CAPBRAN HOLDINGS, LLC. Distributed by CAPITAL BRANDS
DISTRIBUTION, LLC. LOS ANGELES, CA 90025 USA
All Rights Reserved. MADE IN CHINA

Illustrations may differ from the actual product. We are constantly striving
to improve our products, therefore the specifications contained herein
are subject to change without notice.

200603_NBJ50200